

USB CONNECTION MANUAL

Choosing USB pin port according to matching motherboard

Choosing USB pin port of front panel according to motherboard usb pin plug.

Case front panel USB pin plug please refer the following diagram 1 and 2

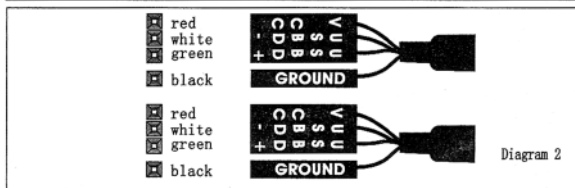
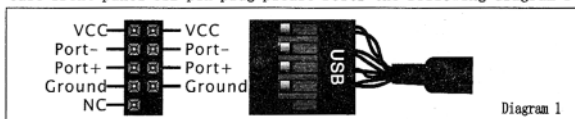

Motherboard usb pin port please refer the following diagram 3

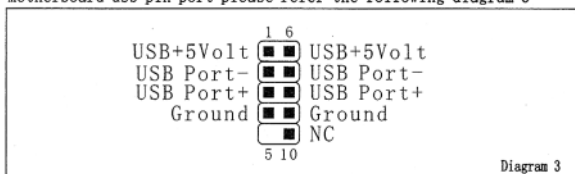

Choosing case front panel usb pin port (eg. diagram 1), insert it into usb pin port of matching motherboard correctly (refer diagram 4)

front usb connection guide

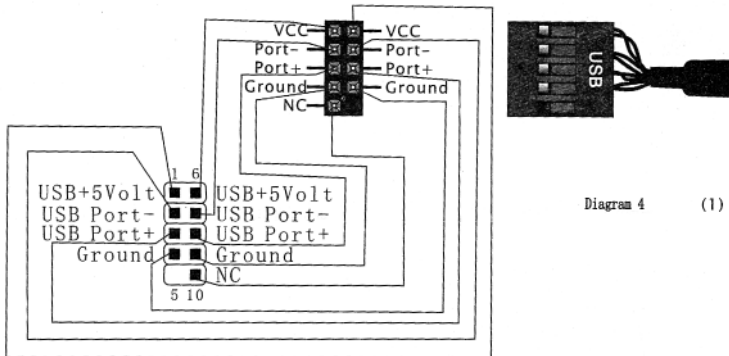

◆ 【Setting COMS window and adding the procedure of USB when start computer】

Press "DEL" and enter into COMS when starting computer, click "Integrated Peripherals" item, then click "On chip USB" and made it enabled, setting over and back to COMS window, click save button to finish setting, when start Computer, system will install USB procedure automatically. If system remind you insert installation disk, put windows 98 or windows 2000 installation disk, install it with guide.

Notice: please refer motherboard installation manual, if there is any doubt, please ask help from professional person. Otherwise it might be cause damage for motherboard by wrong operation.



Any usb type change, please refer the sample, no more special notice.

2. Connect AUX/MIC plug with front AUX/MIC cable of computer case panel.
Connecting AUX/MIC plug in front

◆ AUX/MIC plug of front panel please refer following diagram 5 and 6

Choosing AUX/MIC pin plug according to motherboard audio pin port.

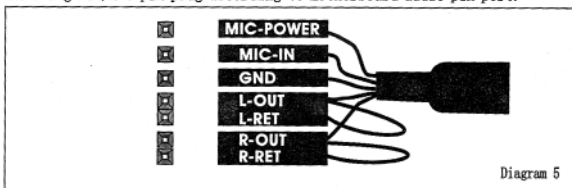

Front audio pin type (FP audio) is different basic on different type of motherboard, popular motherboard has almost same pin port, see diagram as below, please refer diagram 7-10

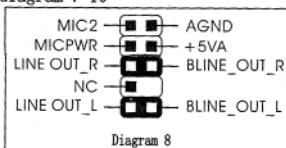
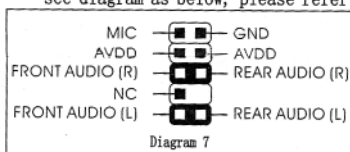

(2)

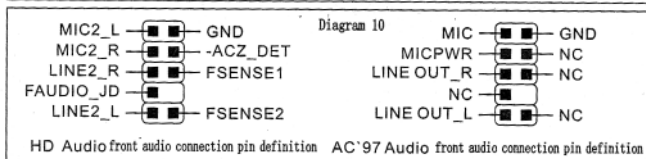
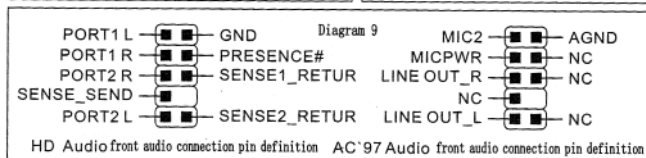

◆ Choosing front audio connection cable (eg. diagram 5), insert it into pin port of motherboard (refer diagram 11)
front audio pin cable diagram

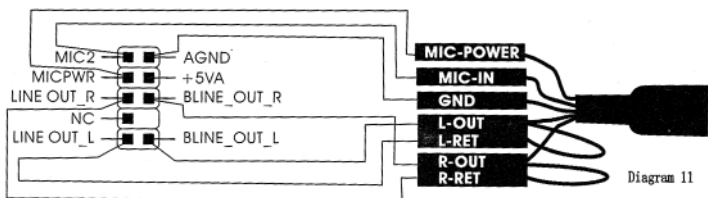

Diagram 9 and 10 are popular HD AUDIO or AC'97 standard audio pin drawing, these kind of motherboard can support HD AUDIO or AC'97 standard audio at the same time. choose audio cable first, then choose <HD AUDIO> or <AC'97 AUDIO> under "front panel support type" item of BIOS procedure advance menu or set <AUTO> from item "Azalia Codec" of BIOS procedure menu "Integrated Peripherals", if you set "disabled", audio function is not available. if audio procedure install successfully, taskbar under right below corner will Show icon under system windows XP, more details, please refer motherboard manual of how to set BIOS procedure.

Notice: please refer motherboard installation manual, if there is any doubt, please ask help from professional person. Otherwise it might be cause damage for motherboard by wrong operation.



Any usb type change, please refer the sample, no more special notice.

(3)